

13" x 16" PEDESTAL ASSEMBLY

P6001215

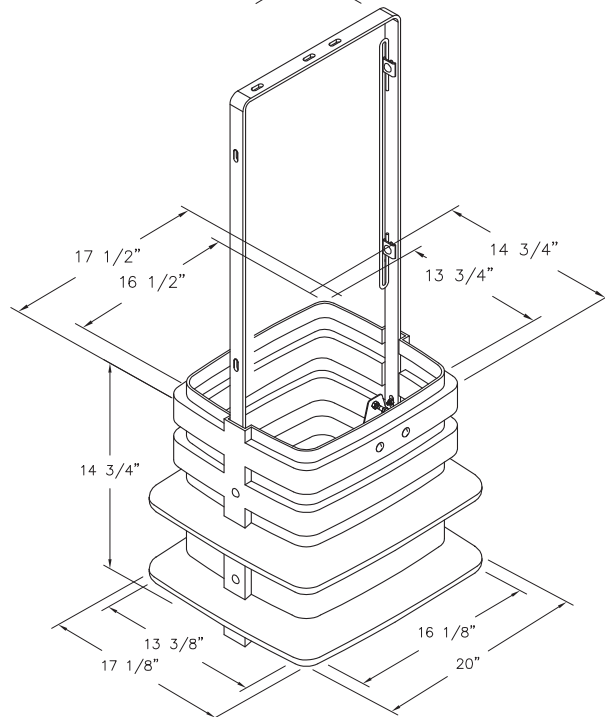

ARMORCAST PRODUCTS COMPANY

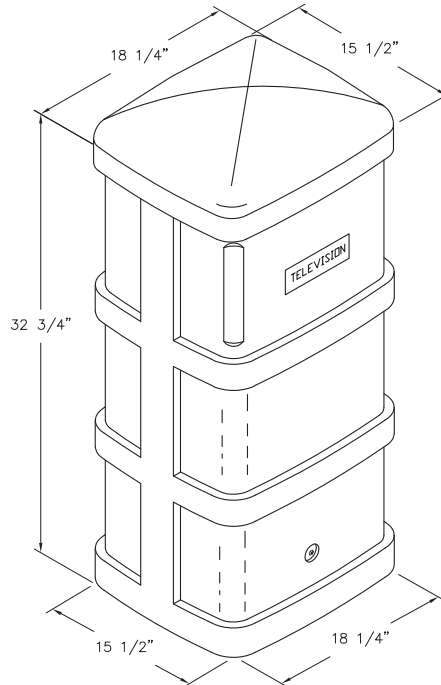

DESCRIPTION	NOMINAL SIZE W x L x D	DOVE HEIGHT	ABOVE GRADE	SERIES PART NUMBER	APPROX. WEIGHT	PALLET QTY.
PEDESTAL	13 x 16 x 32	30	34	P6001215	33 lbs.	10

*Custom colors and custom brackets available. Contact factory for more information. *See page 18 for detailed ordering information.

www.armorcastprod.com Tel: (818) 982-3600 Fax: (818) 982-7742